

# TASCAM<sup>®</sup>

TEAC PROFESSIONAL

D01064220A

# CD-200

## Compact Disc Player

**OWNER'S MANUAL**

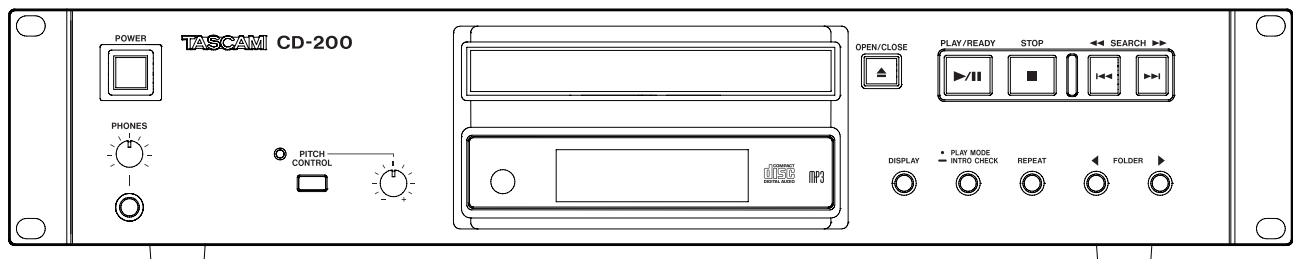

# IMPORTANT SAFETY PRECAUTIONS



CAUTION: TO REDUCE THE RISK OF ELECTRIC SHOCK, DO NOT REMOVE COVER (OR BACK). NO USER-SERVICEABLE PARTS INSIDE. REFER SERVICING TO QUALIFIED SERVICE PERSONNEL.



The lightning flash with arrowhead symbol, within equilateral triangle, is intended to alert the user to the presence of uninsulated "dangerous voltage" within the product's enclosure that may be of sufficient magnitude to constitute a risk of electric shock to persons.



The exclamation point within an equilateral triangle is intended to alert the user to the presence of important operating and maintenance (servicing) instructions in the literature accompanying the appliance.

This appliance has a serial number located on the rear panel. Please record the model number and serial number and retain them for your records.

Model number \_\_\_\_\_

Serial number \_\_\_\_\_

**WARNING: TO PREVENT FIRE OR SHOCK HAZARD, DO NOT EXPOSE THIS APPLIANCE TO RAIN OR MOISTURE.**

## For U.S.A.

### TO THE USER

This equipment has been tested and found to comply with the limits for a Class A digital device, pursuant to Part 15 of the FCC Rules. These limits are designed to provide reasonable protection against harmful interference when the equipment is operated in a commercial environment. This equipment generates, uses, and can radiate radio frequency energy and, if not installed and used in accordance with the instruction manual, may cause harmful interference to radio communications.

Operation of this equipment in a residential area is likely to cause harmful interference in which case the user will be required to correct the interference at his own expense.

### CAUTION

Changes or modifications to this equipment not expressly approved by TEAC CORPORATION for compliance could void the user's authority to operate this equipment.

### CE Marking Information

- a) Applicable electromagnetic environment: E4
- b) Peak inrush current: 2.0 A

In North America use only on 120V supply.

## 产品有毒有害物质或元素的名称及含量

机种: CD-200		有毒有害物质或元素					
品名	铅 (Pb)	汞 (Hg)	镉 (Cd)	六价铬 (Cr6+)	多溴联苯 (PBB)	多溴二苯醚 (PBDE)	
1 CHASSIS 部份	○	○	○	○	○	○	
2 FRONT PANEL 部份	○	○	○	○	○	○	
3 螺丝 部份	○	○	○	○	○	○	
4 线材 部份	○	○	○	○	○	○	
5 PCB Assy 部份	×	○	○	○	○	○	
6 CD MECH 部份	○	○	○	○	○	○	
7 电源 部份	○	○	○	○	○	○	
8 附属品 部份	×	○	○	○	○	○	
9 LABEL 部份	○	○	○	○	○	○	
10 包装 部份	○	○	○	○	○	○	

○: 表示该有毒有害物质在该部件所有均质材料中的含量均在 SJ/T11363-2006 标准规定的限量要求以下。

×: 表示该有毒有害物质至少在该部件的某一均质材料中的含量超出 SJ/T11363-2006 标准规定的限量要求。

(针对现在代替技术困难的电子部品及合金中的铅)

# IMPORTANT SAFETY INSTRUCTIONS

- 1 Read these instructions.
  - 2 Keep these instructions.
  - 3 Heed all warnings.
  - 4 Follow all instructions.
  - 5 Do not use this apparatus near water.
  - 6 Clean only with dry cloth.
  - 7 Do not block any ventilation openings. Install in accordance with the manufacturer's instructions.
  - 8 Do not install near any heat sources such as radiators, heat registers, stoves, or other apparatus (including amplifiers) that produce heat.
  - 9 Do not defeat the safety purpose of the polarized or grounding-type plug. A polarized plug has two blades with one wider than the other. A grounding type plug has two blades and a third grounding prong. The wide blade or the third prong are provided for your safety. If the provided plug does not fit into your outlet, consult an electrician for replacement of the obsolete outlet.
  - 10 Protect the power cord from being walked on or pinched particularly at plugs, convenience receptacles, and the point where they exit from the apparatus.
  - 11 Only use attachments/accessories specified by the manufacturer.
  - 12 Use only with the cart, stand, tripod, bracket, or table specified by the manufacturer, or sold with the apparatus. When a cart is used, use caution when moving the cart/apparatus combination to avoid injury from tip-over.
- 
- 13 Unplug this apparatus during lightning storms or when unused for long periods of time.
  - 14 Refer all servicing to qualified service personnel. Servicing is required when the apparatus has been damaged in any way, such as power-supply cord or plug is damaged, liquid has been spilled or objects have fallen into the apparatus, the apparatus has been exposed to rain or moisture, does not operate normally, or has been dropped.
- Do not expose this apparatus to drips or splashes.
  - Do not place any objects filled with liquids, such as vases, on the apparatus.
  - Do not install this apparatus in a confined space such as a book case or similar unit.
  - The apparatus draws nominal non-operating power from the AC outlet with its POWER or STANDBY/ON switch not in the ON position.
  - The apparatus should be located close enough to the AC outlet so that you can easily grasp the power cord plug at any time.
  - The mains plug is used as the disconnect device, the disconnect device shall remain readily operable.
  - An apparatus with Class I construction shall be connected to an AC outlet with a protective grounding connection.
  - Batteries (battery pack or batteries installed) should not be exposed to excessive heat such as sunshine, fire or the like.
  - CAUTION: Danger of explosion if battery is incorrectly replaced. Replace only with the same or equivalent type.
  - Excessive sound pressure from earphones and headphones can cause hearing loss.

## For the customers in Europe

### WARNING

This is a Class A product. In a domestic environment, this product may cause radio interference in which case the user may be required to take adequate measures.

## Pour les utilisateurs en Europe

### AVERTISSEMENT

Il s'agit d'un produit de Classe A. Dans un environnement domestique, cet appareil peut provoquer des interférences radio, dans ce cas l'utilisateur peut être amené à prendre des mesures appropriées.

## Für Kunden in Europa

### Warnung

Dies ist eine Einrichtung, welche die Funk-Entstörung nach Klasse A besitzt. Diese Einrichtung kann im Wohnbereich Funkstörungen verursachen; in diesem Fall kann vom Betreiber verlangt werden, angemessene Maßnahmen durchzuführen und dafür aufzukommen.

# Safety Information

## CAUTIONS ABOUT BATTERIES

This product uses batteries. Misuse of batteries could cause a leak, rupture or other trouble. Always abide by the following precautions when using batteries.

- Never recharge non-rechargeable batteries. The batteries could rupture or leak, causing fire or injury.
- When installing batteries, pay attention to the polarity indications (plus/minus (+/-) orientation), and install them correctly in the battery compartment as indicated. Putting them in backward could make the batteries rupture or leak, causing fire, injury or stains around them.
- When you store or dispose batteries, isolate their terminals with insulation tape or something like that to prevent them from contacting other batteries or metallic objects.
- When throwing used batteries away, follow the disposal instructions indicated on the batteries and the local disposal laws.
- Do not use batteries other than those specified. Do not mix and use new and old batteries or different types of batteries together. The batteries could rupture or leak, causing fire, injury or stains around them.
- Do not carry or store batteries together with small metal objects. The batteries could short, causing leak, rupture or other trouble.
- Do not heat or disassemble batteries. Do not put them in fire or water. Batteries could rupture or leak, causing fire, injury or stains around them.
- If the battery fluid leaks, wipe away any fluid on the battery case before inserting new batteries. If the battery fluid gets in an eye, it could cause loss of eyesight. If fluid does enter an eye, wash it out thoroughly with clean water without rubbing the eye and then consult a doctor immediately. If the fluid gets on a person's body or clothing, it could cause skin injuries or burns. If this should happen, wash it off with clean water and then consult a doctor immediately.
- The unit power should be off when you install and replace batteries.
- Remove the batteries if you do not plan to use the unit for a long time. Batteries could rupture or leak, causing fire, injury or stains around them. If the battery fluid leaks, wipe away any fluid on the battery compartment before inserting new batteries.
- Do not disassemble a battery. The acid inside the battery could harm skin or clothing.

## CAUTIONS ABOUT LASER RADIATION

This product has been designed and manufactured according to FDA regulations "title 21, CFR, chapter 1, subchapter J, based on the Radiation Control for Health and Safety Act of 1968," and is classified as a class 1 laser product. There is no hazardous invisible laser radiation during operation because invisible laser radiation emitted inside of this product is completely confined in the protective housings.

The label required in this regulation is shown at ①.

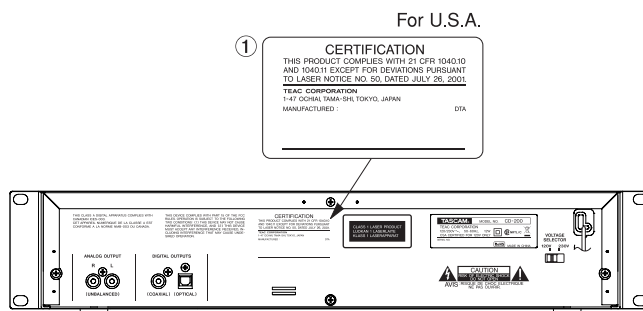

## Cautions:

- DO NOT REMOVE THE PROTECTIVE HOUSING USING A SCREWDRIVER.
- USE OF CONTROLS OR ADJUSTMENTS OR PERFORMANCE OF PROCEDURES OTHER THAN THOSE SPECIFIED HEREIN MAY RESULT IN HAZARDOUS RADIATION EXPOSURE.
- IF THIS PRODUCT DEVELOPS TROUBLE, CONTACT YOUR NEAREST QUALIFIED SERVICE PERSONNEL, AND DO NOT USE THE PRODUCT IN ITS DAMAGED STATE.
- CLASS 1M INVISIBLE LASER RADIATION WHEN OPEN AND INTERLOCKS DEFEATED. DO NOT VIEW DIRECTLY WITH OPTICAL INSTRUMENTS.

### Optical pickup

Type	: SF-P101VF
Manufacturer	: SANYO Electric Co., Ltd.
Laser output	: Less than 0.25 mW on the objective lens
Wavelength	: 760 to 820 nm

## RACK-MOUNTING THE UNIT

If you are mounting the unit in a rack, leave 1U of space above it and 4 inch (10 cm) or more of space at the rear.

Use the rack-mounting kit to mount the unit in a standard 19-inch equipment rack, as shown below. Remove the feet of the unit before mounting.

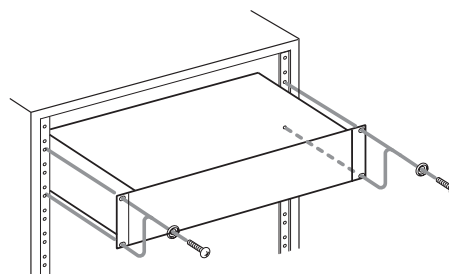

<b>1 – Introduction .....</b>	<b>6</b>	Pitch control .....	21
Main features .....	6	Intro Check .....	22
Included items .....	6	<b>5 – Message Lists .....</b>	<b>23</b>
About this manual .....	6	Operation messages .....	23
Trademarks .....	6	Warning messages .....	23
Precautions and notes for placement and use .....	7	Error messages .....	23
Beware of condensation .....	7	<b>6 – Troubleshooting .....</b>	<b>24</b>
Cleaning the unit .....	7	<b>7 – Specifications .....</b>	<b>25</b>
About discs .....	7	Ratings .....	25
Handling of compact discs .....	7	General .....	25
<b>2 – Names and Functions of Parts .....</b>	<b>8</b>	Dimensions .....	26
Front panel .....	8		
Rear panel .....	9		
Remote control unit (RC-CD200) .....	10		
Display .....	11		
<b>3 – Preparation for Use .....</b>	<b>12</b>		
Connections .....	12		
Connecting headphones .....	12		
Connecting other audio equipment .....	12		
Preparing the remote control .....	13		
Inserting batteries .....	13		
Replacing the batteries .....	13		
Cautions about the use of batteries .....	13		
Cautions about using the remote control .....	13		
<b>4 – Playing back CDs .....</b>	<b>14</b>		
Discs that can be played .....	14		
Folders and tracks on data CDs .....	14		
Loading a CD .....	15		
Playback .....	15		
Selecting a track .....	16		
Skipping to the next or previous track ..	16		
Selecting by track number .....	16		
Search forward and backward .....	16		
Folder playback (with data CDs only) .....	17		
Selecting the folder .....	17		
Playback modes .....	17		
Select the playback mode .....	17		
Programmed playback .....	18		
Setting the program .....	18		
Checking the program .....	19		
Replacing a program track .....	20		
Adding more program tracks .....	20		
Clearing the program .....	20		
Time and text information display .....	20		
Repeat playback .....	21		

# 1 – Introduction

Thank you for your purchase of the TASCAM CD-200 Compact Disc Player.

Before connecting and using the unit, please take time to read this manual thoroughly to ensure you understand how to properly set up and connect the unit, as well as the operation of its many useful and convenient functions. After you have finished reading this manual, please keep it in a safe place for future reference.

You can also download the Owner's Manual from the TASCAM web site (<http://www.tascam.com>).

---

## Main features

---

- In addition to audio CDs (CD-DA), plays data CDs (CD-ROM) on which WAV and MP3 format files are recorded.
- CD-R/RW playback
- 2U EIA rack mount size
- Analog output (RCA) and digital outputs (coaxial and optical)
- Headphone output with level control
- 10-key wireless remote control
- Displays textual information (artist name, album name, track name, etc.) including CD text and ID3 tags.
- Three types of play mode (continuous, shuffle, and programmed)
- Repeat playback (single repeat, all repeat)
- $\pm 12.5\%$  pitch control
- Intro check
- Folder repeat for data CDs
- Various time display (track elapsed time, track remaining time and total remaining time for audio CDs, total elapsed time for data CDs).
- 10-second shockproof memory built-in (protection against skipping).

---

## Included items

---

The included items are listed below.

Take care when opening the package not to damage the items. Keep the package materials for transportation in the future.

Please contact the store where you purchased this unit if any of these items are missing or have been damaged during transportation.

- Main unit .....1
- Wireless remote control unit (RC-CD200).....1
- AA batteries for the remote control unit.....2

- A rack-mounting screw kit.....1
- A warranty card .....1
- Owner's manual (this manual) .....1

### NOTE

*The batteries are not supplied for Taiwan.*

---

## About this manual

---

In this manual, we use the following conventions:

- The names of keys and controls are given in the following typeface: **DISPLAY**.
- When the alphanumeric portion of the display shows a message, this is shown in the following typeface: **OPEN**.
- If a preset indicator in the display (i.e. one which cannot change) is shown, this is shown as follows: **INTRO**.
- The CD-DA format may also be mentioned as “audio CD” format.
- CDs on which MP3 or WAV audio files are recorded may be mentioned as “data CDs”.
- Additional information is introduced in the styles below when needed:

### TIP

*Useful hints when using the unit.*

### NOTE

*Explanation of actions in special situation and supplement.*

### CAUTION

*Instructions that should be followed to avoid injury, damage to the unit or other equipment, and loss of data.*

---

## Trademarks

---

- TASCAM is a registered trademark of TEAC Corporation.
- MPEG Layer-3 audio coding technology licensed from Fraunhofer IIS and Thomson.
- Other company names, product names and logos in this document are the trademarks or registered trademarks of their respective owners.



# 1 – Introduction

## Precautions and notes for placement and use

- The operating temperature should be between 5°C and 35°C (41°F and 95°F).
- Make sure that the unit is mounted in a level position for correct operation.
- Do not place any object on the unit for heat dissipation.
- Avoid installing this unit on top of any heat-generating electrical device such as a power amplifier.

## Beware of condensation

If the unit (or a compact disc) is moved from a cold to a warm place, or used after a sudden temperature change, there is a danger of condensation; vapor in the air could condense on the internal mechanism, making correct operation impossible. To prevent this, or if this occurs, let the player sit for one or two hours at the new room temperature before using.

## Cleaning the unit

To clean the unit, wipe gently with a soft dry cloth. Do not use any benzene, paint thinner, ethyl alcohol or other chemical agents to clean the unit as they could damage the surface.

## About discs

In addition to audio CDs (CD-DA), the CD-200 can play CD-R and CD-RW discs on which audio CD, MP3, or WAV format files are recorded. The CD player can also play 3-inch CDs

## Handling of compact discs

- Always place the compact discs in the trays with their label facing upward.
- To remove a disc from its case, press down on the center of the disc holder, then lift the disc out, holding it carefully by the edges.

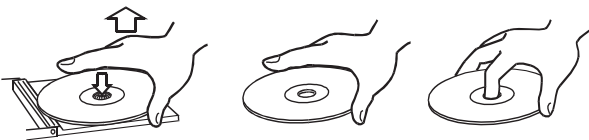

- Avoid getting fingerprints on the signal side (the non-label side). Grime and dust may cause skipping or malfunction.
- To clean the signal side of a disc, wipe gently with a soft dry cloth from the center towards the outside edge. Dirt on discs can lower the sound quality, so clean them

and always store them in a clean state.

- Do not use any record spray, anti-static solutions, benzene, paint thinner or other chemical agents to clean CDs as they could damage the delicate playing surface. It may cause CDs to become unplayable.
- Do not affix any labels or stickers to the label side of the disc and do not use any protective coating spray. Do not insert discs that have adhesive remaining from tape or stickers that have been removed. If they are inserted into the player, they could stick to the internal mechanism, requiring removal by a technician.
- Never use a commercially available CD stabilizer. Using stabilizers with this player will damage the mechanism and cause it to malfunction.
- Do not use cracked discs.
- Only use circular compact discs. Avoid using non-circular promotional, etc. discs.



- When labeling CD-R and CD-RW discs, always use a soft oil-based felt-tipped pen to write the information. Never use a ball-point or hard-tipped pen, as this may cause damage to the recorded side.
- Music discs with copy control, a copy-protection system, have been released from several record companies in an attempt to protect the copyright. Since some of these discs do not comply with the CD specifications, they may not be playable on the CD-200.

## 2 – Names and Functions of Parts

### Front panel

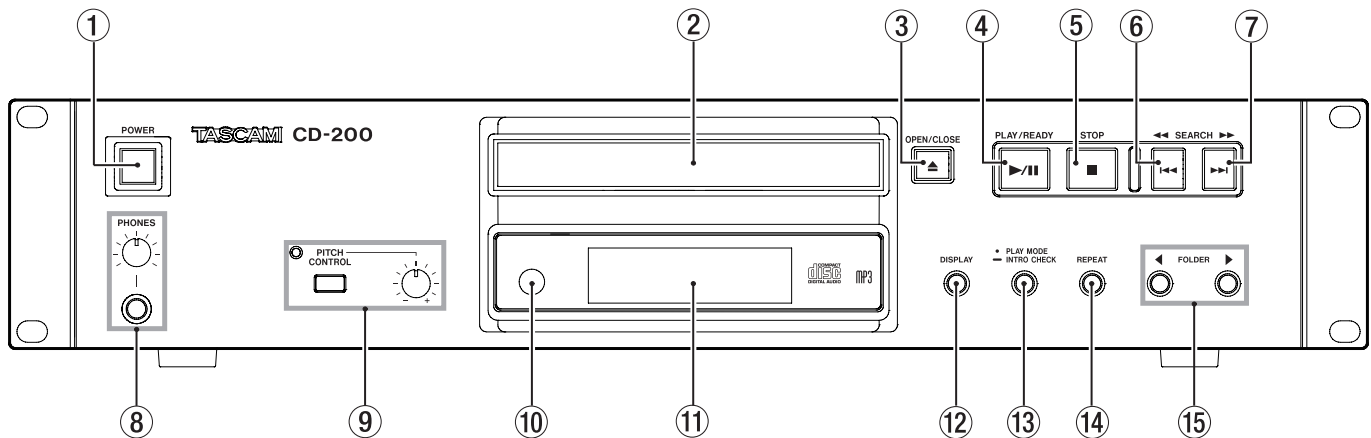

- ① **POWER**  
Press this switch to turn the unit on or off.
- ② **Disc tray**
- ③ **OPEN/CLOSE**  
Use this key to open and close the disc tray.
- ④ **PLAY/READY (▶/||)**  
Use this key to start or pause playback.
- ⑤ **STOP (■)**  
Use this key to stop playback.
- ⑥ **SEARCH ◀◀ [◀◀]**  
Press this key briefly to skip to the previous track. Hold down this key to search for a part of a track in the reverse direction.
- ⑦ **SEARCH ▶▶ [▶▶]**  
Press this key briefly to skip to the next track. Hold down this key to search for a part of a track in the forward direction.
- ⑧ **PHONES jack and knob**  
For private listening, insert the headphones plug into this standard 1/4" stereo phone jack, and adjust the volume by turning the level knob.
- ⑨ **PITCH CONTROL switch, indicator and knob**  
Use this switch to turn the pitch control function on or off. When the function is on, the indicator will light. Adjust the amount ( $\pm 12.5\%$ ) by turning the knob. (See "Pitch control" on page 21.)
- ⑩ **Remote Sensor**  
When operating the remote control unit, point it towards here.
- ⑪ **Display**  
Displays various information.
- ⑫ **DISPLAY**  
Press this key to show for two seconds the type of information (playback time or text information) that currently appears in the main area of the display.
- ⑬ **PLAY MODE/INTRO CHECK**  
Press this key again while this is being shown to change the type of information displayed. The type of information that can be shown depends on the type of disc loaded and the operation status. (See "Time and text information display" on page 20.)
- ⑭ **REPEAT**  
Press this key to select single repeat or all repeat playback. Press this key again to stop repeat playback. (See "Repeat playback" on page 21.)
- ⑮ **FOLDER (◀▶)**  
Use these keys when a data CD is in the player to change the playback folder. By selecting "ALL," every folder on the disc is made subject to playback. (See "Folder playback (with data CDs only)" on page 17.)



## 2 – Names and Functions of Parts

### Rear panel

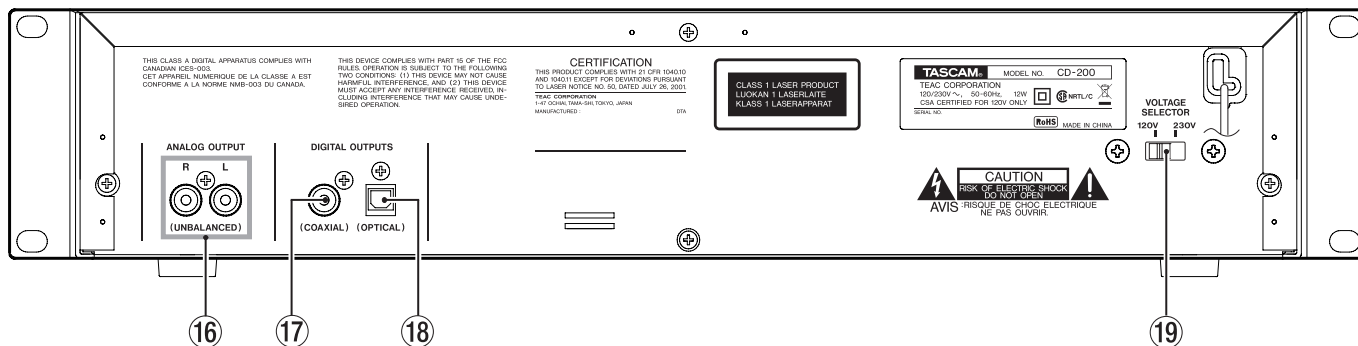

- ⑩ **ANALOG OUTPUT (UNBALANCED) jacks**  
The CD playback signal is output here as stereo analog signals (–10 dBV).
- ⑪ **DIGITAL OUTPUT (COAXIAL) jack**  
The CD playback signal is output here as a digital signal in S/PDIF format.
- ⑫ **DIGITAL OUTPUT (OPTICAL) jack**  
The CD playback signal is output here as a digital signal in S/PDIF format.
- ⑬ **VOLTAGE SELECTOR**  
Switches the voltage to either **230 V** or **120 V**.

#### NOTE

- *The voltage selector is only available on units for specific markets.*
- *In North America, use only on 120V supply.*

## 2 – Names and Functions of Parts

### Remote control unit (RC-CD200)

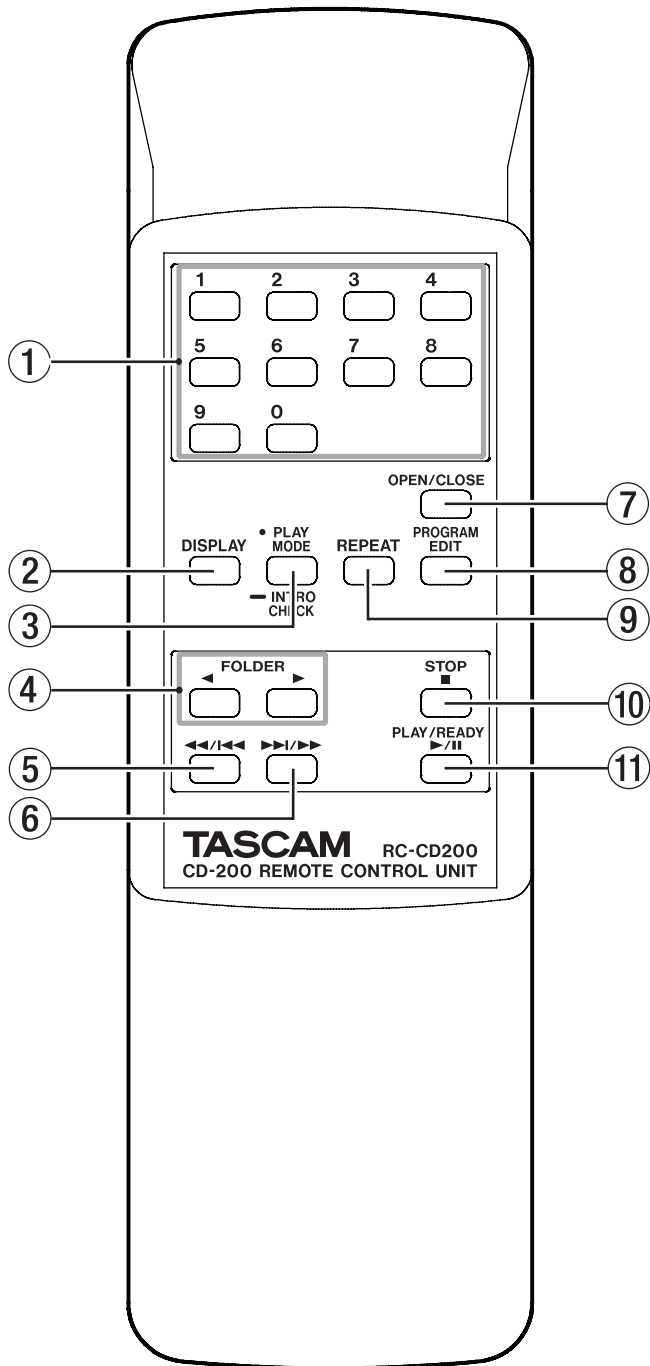

- ① **Numeric keys**  
Use these keys to select tracks.
- ② **DISPLAY**  
Press this key to show for two seconds the type of information (playback time or text information) that currently appears in the main area of the display. Press this key again while this is being shown to change the type of information displayed. The type of information that can be shown depends on the type of disc loaded and the operation status. (See “Time and text information display” on page 20.)
- ③ **PLAY MODE/INTRO CHECK**  
Press briefly to change the playback mode. The three playback modes are continuous, shuffle and programmed. (See “Playback modes” on page 17.) Press and hold this key to use the Intro Check function. (See “Intro Check” on page 22.)
- ④ **FOLDER ◀/▶**  
Use these keys when a data CD is in the player to change the playback folder. By selecting “ALL,” every folder on the disc is made subject to playback. (See “Folder playback (with data CDs only)” on page 17.)
- ⑤ **◀◀/▶▶**  
Press this key briefly to skip to the previous track. Hold down this key to search for a part of a track in the reverse direction.
- ⑥ **▶▶/▶▶**  
Press this key briefly to skip to the next track. Hold down this key to search for a part of a track in the forward direction.
- ⑦ **OPEN/CLOSE**  
Use this key to open and close the disc tray.
- ⑧ **PROGRAM EDIT**  
Use this to set, confirm and edit programs. (See “Programmed playback” on page 18.)
- ⑨ **REPEAT**  
Press this key to select single repeat or all repeat playback. Press this key again to stop repeat playback. (See “Repeat playback” on page 21.)
- ⑩ **STOP**  
Use this key to stop playback.
- ⑪ **PLAY/READY**  
Use this key to start or pause playback.

## 2 – Names and Functions of Parts

### Display

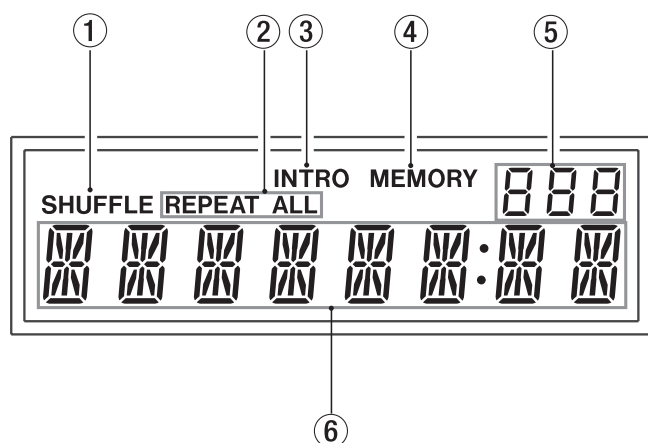

- ① **SHUFFLE**  
**SHUFFLE** lights when this function is on.
- ② **REPEAT**  
**REPEAT ALL** appears when it is set and **REPEAT** appears when single repeat is set.
- ③ **INTRO**  
**INTRO** lights when this function is on.
- ④ **MEMORY**  
**MEMORY** lights when programmed playback is on and blinks while you are setting the program.
- ⑤ **Folder number**  
When a data CD is in the unit, the folder number is shown when set to folder playback, and **ALL** is shown when set to disc playback (all folders). When an audio CD is in the unit, **cd** is shown.
- ⑥ **Main display**  
The track number and time or text information is shown. The status of the unit (**OPEN**, **CLOSE**, **TOC\***, **READ**, etc.) and messages (**NO DISC**, etc.) are also shown. Items with more than eight characters are scrolled when shown.

\* *TOC means "Table Of Contents," which is track information written on the disc*

# 3 – Preparation for Use

## Connections

### Headphones

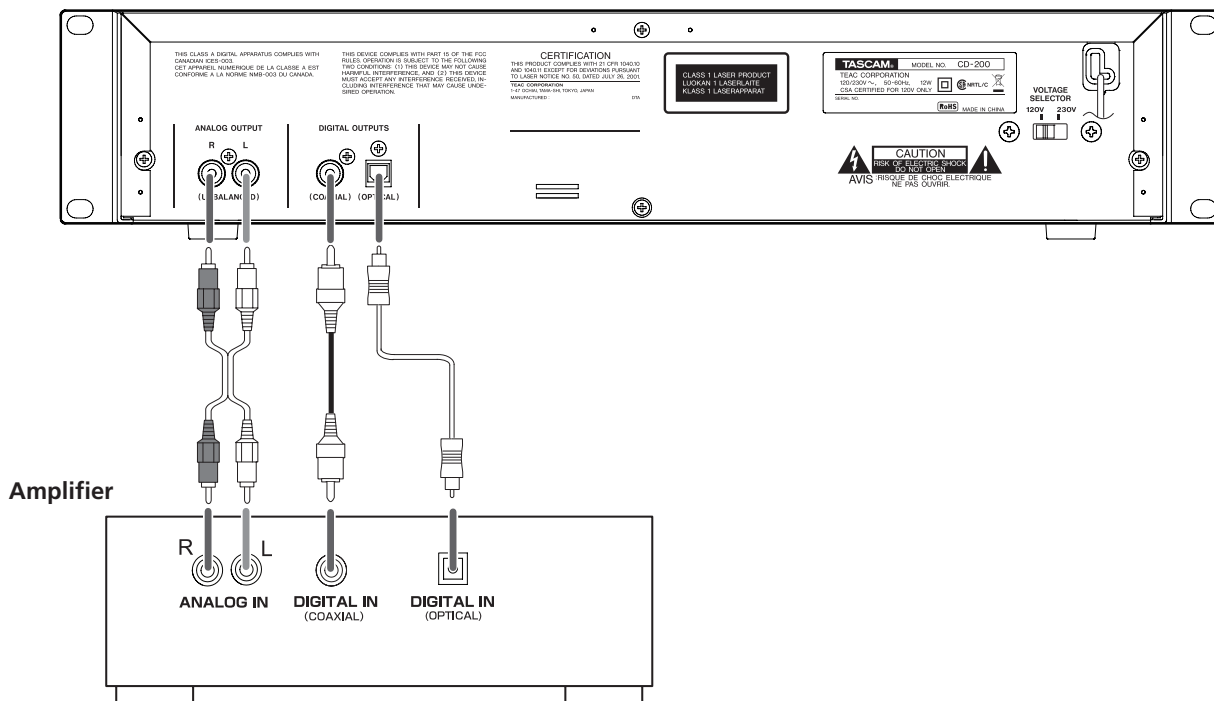
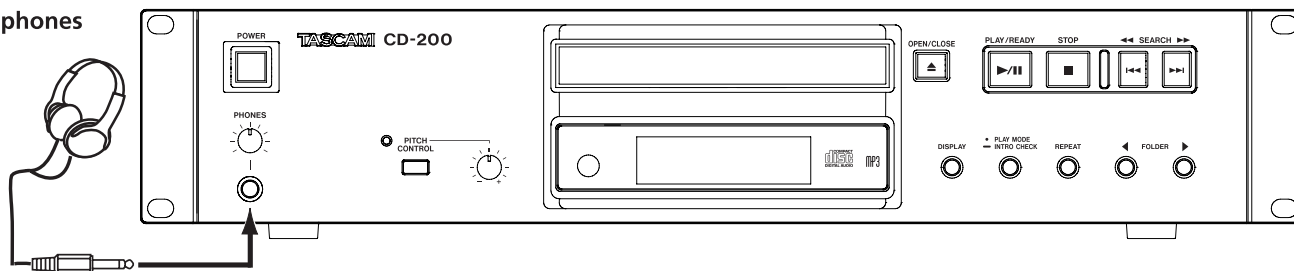

### Connecting headphones

Connect stereo headphones to the **PHONES** jack on the front panel. Use the knob to adjust the level.

### Connecting other audio equipment

Sound from this unit can be output as an analog or digital signal to, for example, an external amplifier or mixer. Unbalanced analog signals are output from the **ANALOG OUTPUT** jacks (RCA pin jacks), and digital signals are output from the **DIGITAL OUTPUT** jacks in S/PDIF format. The unit has two types of **DIGITAL OUTPUT** jacks—coaxial and optical—allowing connection to equipment with both types of inputs.

#### CAUTION

- *When making a digital connection, use either the coaxial or optical connector.*
- *To dub a recording digitally, prepare the disc for playback in this unit before starting recording with the recording device.*

# 3 – Preparation for Use

## Preparing the remote control

### Inserting batteries

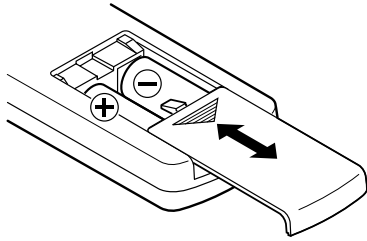

1. Open the lid.
2. Confirm +/- polarity, and insert two AA batteries.
3. Close the lid.

#### NOTE

The batteries are not supplied for Taiwan.

### Replacing the batteries

Replace both batteries with new ones when the range of the remote control becomes short or if the function keys become unresponsive.

### Cautions about the use of batteries

Misuse of batteries could cause them to leak, rupture or otherwise be damaged. Please read and abide by the precautions on them when using batteries. Also see "Cautions about batteries" on page 4.

### Cautions about using the remote control

- When using other devices controlled by infrared rays, use of this remote control might operate these devices by mistake.
- Use the remote control within the following range.

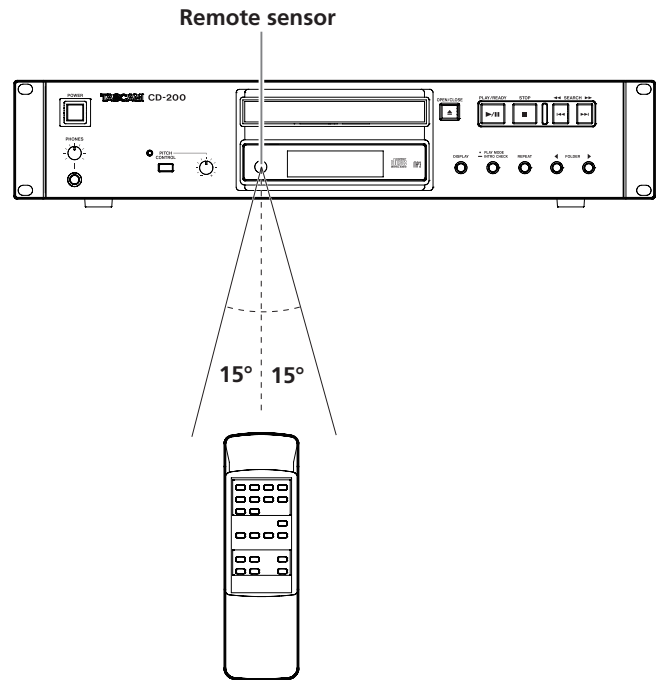

### Operation distance

Directly in front: Within 7 meters

15° left or right: Within 7 meters

# 4 – Playing back CDs

## Discs that can be played

This unit can play the following types of files and discs.

### ■ CD-DA (audio CD) format discs

Music CDs that are commercially available and CD-R and CD-RW discs that have been recorded as audio CD format can be played. In this manual, these types of discs are called “audio CDs.”

### ■ CD-ROM (data CD) format discs

Discs with MP3 and WAV files recorded on them can be played. In this manual, these types of discs are called “data CDs.”

#### NOTE

MP3 files that have a sampling frequency of 32, 44.1 or 48 kHz and a bit-rate of 32–320 kbps or a variable bit-rate (VBR) can be played back. WAV files that have a sampling frequency of 8–48 kHz and are 8-bit or 16-bit can be played back.

#### CAUTION

##### Limitations of MP3 files that use VBR compression

Due to format limitations, positions cannot be accurately detected in VBR files. For this reason, the point where playback actually starts might differ slightly from the point set in advance for functions of this player when points must be set in the middle of a track.

## Folders and tracks on data CDs

This unit treats all the audio files (WAV and MP3) on data CDs as “tracks.” Some data CDs store files inside folders in the same way that ordinary computers do. In addition, multiple folders can be stored inside another folder creating a multilevel structure.

This unit assigns a folder number to each folder to manage them. Folder numbers are assigned sequentially starting with the first folder at the highest level followed by the folders (subfolders) inside it. Folders inside a higher-level folder are numbered in order before the next folder in the higher-level is numbered as shown in the illustration below.

If the root folder of a data CD contains one or more audio files, it will be numbered as the first folder.

Each audio file is also assigned a track number. Track numbers are assigned in order starting from those in the lowest numbered folder.

During ordinary playback of data CDs, tracks are played back just like an audio CD in the order of their assigned numbers.

Folders that do not directly contain audio files are not given numbers. For example, in the illustration below the folder that contains folder 5 is not given a number.

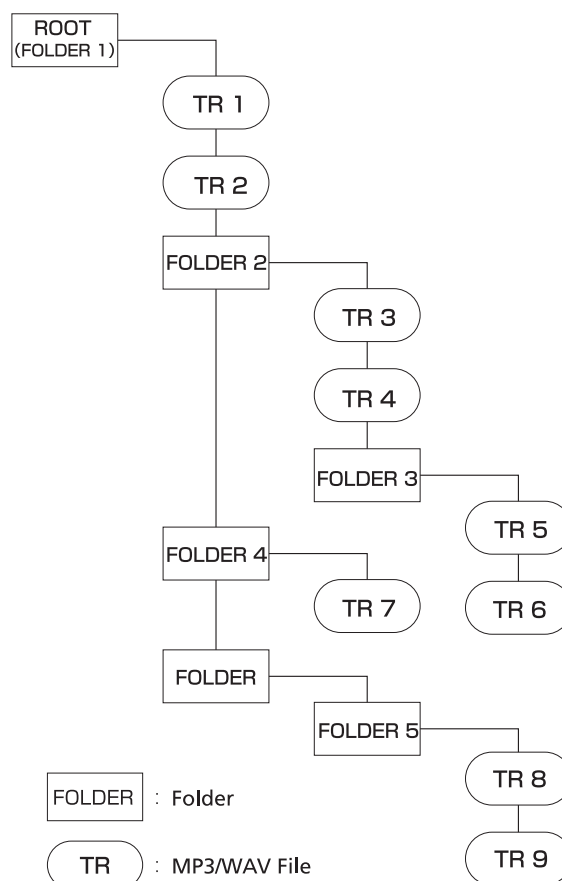

<An Example of Data CD Structure>



# 4 – Playing back CDs

## Loading a CD

To load a CD, press the **OPEN/CLOSE** key on the main unit or on the remote control to open the disc tray, and put the CD into the tray with the label facing up.

Press the **OPEN/CLOSE** key again to close the disc tray. After loading the disc, the unit reads the disc's information and shows on the display the total number of tracks and total playback time if it is an audio CD and the total number of tracks in the current folder if it is a data CD.

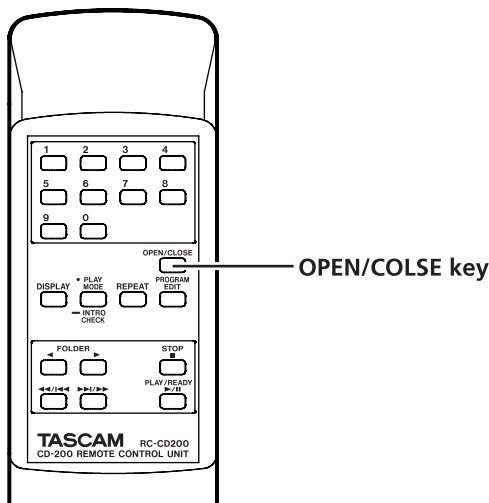
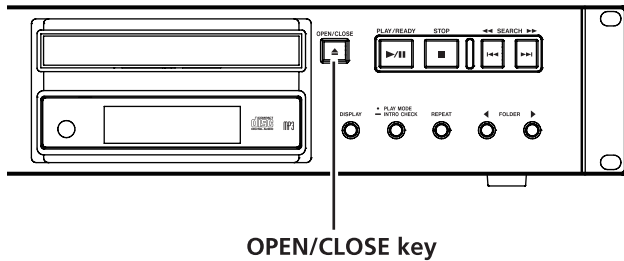

### NOTE

Instead of pressing the **OPEN/CLOSE** key to close the disc tray, you can press the **PLAY/READY** key to close the disc tray and begin playback immediately.

### CAUTION

If you open the disc tray while this unit is in use, the following settings are lost.

- Program
- Current folder (for data CDs)

## Playback

The following procedures assume that the necessary connections have been completed, the unit's power has been turned on and a CD (audio or data) has been loaded.

**Press the PLAY/READY key on the main unit or remote control to begin playback of a CD.**

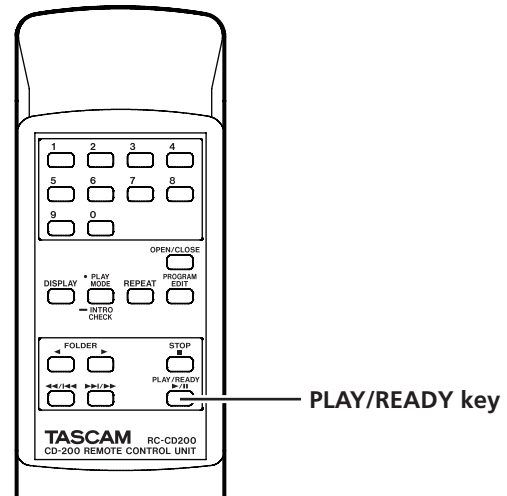
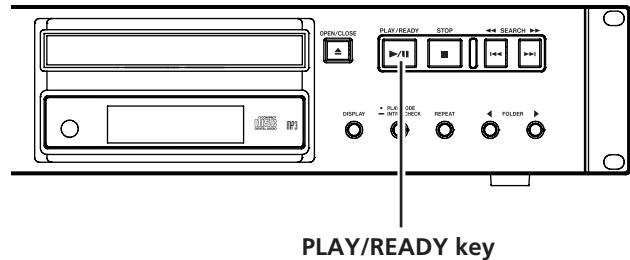

### ■ Stopping playback:

Press the **STOP** key on the main unit or the remote control.

### ■ Pausing playback:

Press the **PLAY/READY** key on the main unit or the remote control.

In this manual, unless stated otherwise, explanations are given assuming that continuous playback mode is set. (See "Playback modes" on page 17.)

# 4 – Playing back CDs

## Selecting a track

There are two ways to select a track. You can move (skip) to the previous or next track, or you can select a track directly by its track number.

## Skipping to the next or previous track

Press a SEARCH  $\lll/\ggg$  ( $\lll/\ggg$ ) key on the main unit or a search ( $\lll/\lll$ ,  $\ggg/\ggg$ ) key on the remote control.

After selecting the track, press the PLAY/READY key on the main unit or the remote control to start track playback.

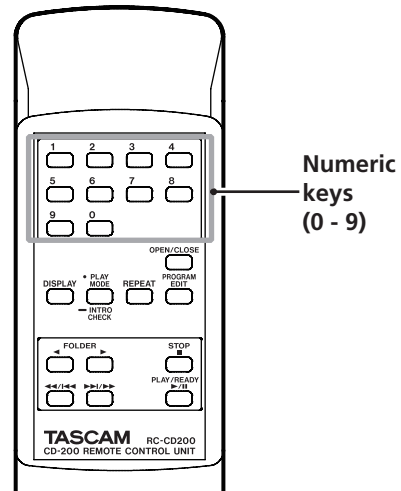
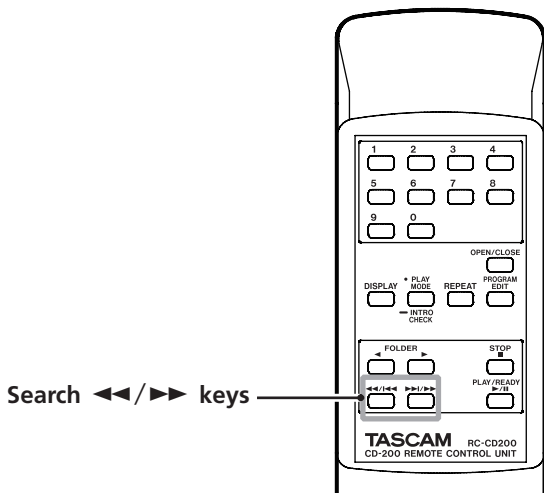
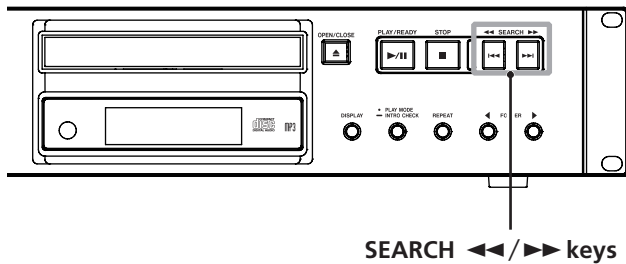

- To select track 1:  
Press the “1” key one time.
  - To select track 12:  
Press the “1” key followed by the “2” key.
- 2 Press the PLAY/READY key on the main unit or the remote control.  
  
The selected track begins to play.  
  
If you press the STOP key on the main unit or the remote control, the display stops showing the track number input and the display returns to its previous state.

### NOTE

The numeric keys cannot be used to select a track when in program or shuffle mode.

## Selecting by track number

Use the numeric keys (0–9) on the remote control to directly set a track for playback by number.

Track numbers can have up to two digits for audio CDs and up to three digits for data CDs.

- 1 Use the remote control numeric keys (0–9) to input the track number. Input the track number starting with the first digit as in the example below.
- 2 Press and hold a SEARCH  $\lll/\ggg$  ( $\lll/\ggg$ ) key on the main unit or a search ( $\lll/\lll$ ,  $\ggg/\ggg$ ) key on the remote control to start searching forward or backward.
- 3 Release the key that you are holding to stop searching and return the unit to the state it was in before searching (playback or pause).

## Search forward and backward

You can search forward and backward in a track while listening to it.

# 4 – Playing back CDs

## Folder playback (with data CDs only)

When playing a data CD, you can set a designated folder (the current folder) as the playback area. Follow the procedures below to set the playback folder. You can also set the playback area to be the entire disc by selecting “ALL.”

### Selecting the folder

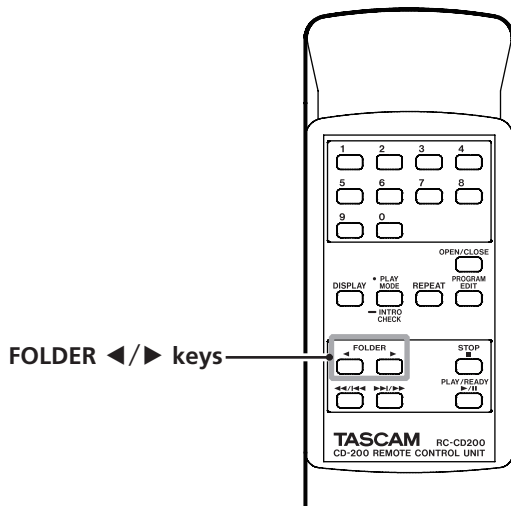
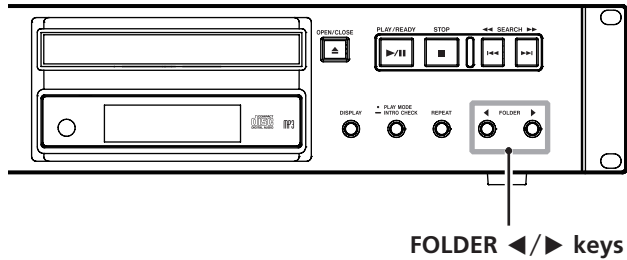

When using a data CD, by pressing the **FOLDER </>** keys on the main unit or the remote control, you can skip to the previous or next folder. This will skip to the beginning of the first track in the previous or next folder. If you hold down one of these keys, you can skip through folders continually.

#### NOTE

When you skip to a different folder, it becomes the current folder.

## Playback modes

This unit can play tracks using three types of playback modes.

### Continuous playback (default setting)

The tracks on a disc are played back in numerical order.

#### NOTE

In folder playback mode, the tracks in the current playback folder on a data CD are played back in numerical order. See “Folder playback (with data CDs only)” on page 17 for details.

### Shuffle playback

The tracks on the disc are played back in random order regardless of their track numbers. Playback stops after all tracks have been played once.

#### NOTE

In folder playback mode, the tracks in the playback folder on a data CD are played back in random order. See “Folder playback (with data CDs only)” on page 17 for details.

### Programmed playback

Tracks are played back in the programmed order. See “Programmed playback” on page 18 for details.

## Select the playback mode

Press the **PLAY MODE/INTRO CHECK** key on the main unit or the remote control to cycle through the playback modes.

During playback, however, only continuous playback and shuffle playback modes can be set.

To select programmed playback, press the **PLAY MODE/INTRO CHECK** key when playback is stopped or no CD is loaded.

An indicator for the current mode will appear on the display as shown below.

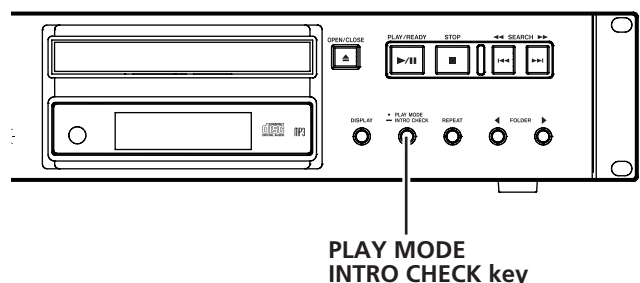

# 4 – Playing back CDs

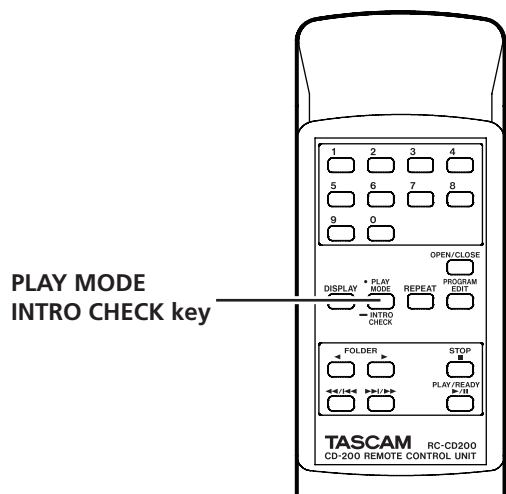

Display	Playback mode
No indication	Continuous playback
SHUFFLE	Shuffle playback
MEMORY	Programmed playback

The selected playback mode is retained even when the power is turned off.

**NOTE**

- Immediately after pressing the PLAY MODE/INTRO CHECK key, the selected mode is shown on the main display area as follows.
  - Continuous playback mode set: CONTINUE
  - Shuffle playback mode set: SHUFFLE
  - Programmed playback mode set: PROGRAM
- In this manual, unless stated otherwise, explanations are given assuming that continuous playback mode is set.

## Programmed playback

To use programmed playback, you must set a program either before or after setting the playback mode to programmed playback mode. (See “Select the playback mode” on page 17.)

When in programmed playback mode, press the PLAY/READY key on the main unit or the remote control to start playback of the set program in order from the first track (program step 01). Press a SEARCH (◀◀/▶▶) (◀◀/▶▶) key on the main unit or a search (◀◀/▶▶, ▶▶/▶▶) key on the remote control to skip to the previous or next program step.

In programmed playback mode, when playback is stopped the total number of tracks in the program and the total program time are shown (total program time is not shown when using a data CD).

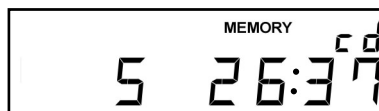

## Setting the program

When no program is set, follow the procedures below to set a program using the remote control.

**NOTE**

- The program cannot be set from the main unit.
  - You can set a program at any time regardless of the current playback mode.
  - The program is cleared when the disc tray is opened.
- 1 Press the PROGRAM EDIT key while playback is stopped.

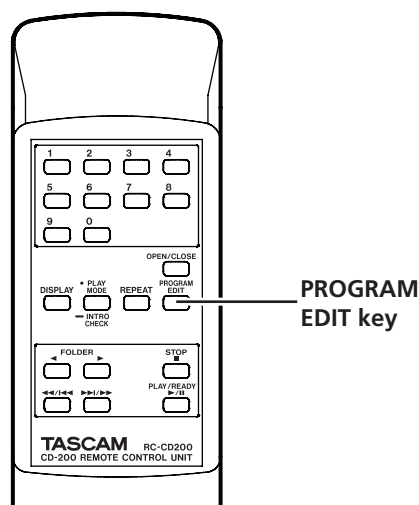

## 4 – Playing back CDs

The unit enters program setting mode, and if no program has been set, it will be possible to set a track to program step 01 (**MEMORY** indicator blinks).

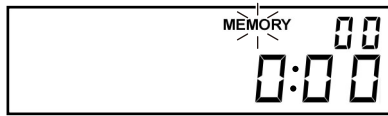

[Audio CD]

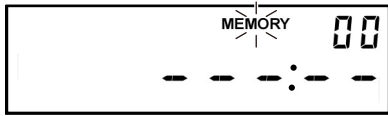

[Data CD]

### NOTE

If the program is already set, the track number and playback time of the track set as program step 01 is shown. (See "Checking the program" on page 19.)

- Use the numeric keys or search (◀◀/|◀◀, ▶▶/|▶▶) keys to select a track to set as program step 01. (The **MEMORY** indicator and the track number blink.) When using the numeric keys, input the number starting with the leftmost digit.

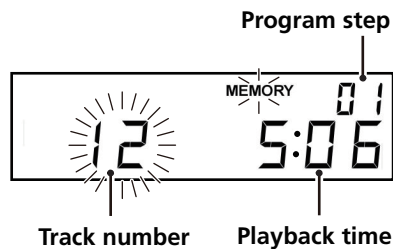

[Audio CD]

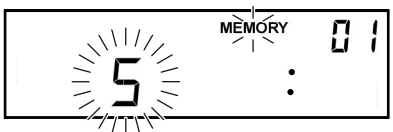

[Data CD]

### NOTE

- When using a data CD, the screen switches to file name display if more than a second passes after pressing a numeric key or search (◀◀/|◀◀, ▶▶/|▶▶) key, but it is still possible to add the track to the program.
- If you press the **STOP** key while a track is selected, selection of that track is canceled, and the screen returns to the state where you can select a track.

- Press the **PROGRAM EDIT** key.

The selected track is added to program step 01. The unit is now ready for you to add another track for the next program step.

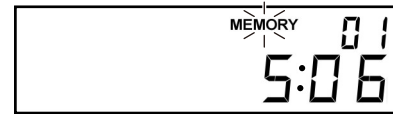

- By repeating steps two and three above, you can add more tracks sequentially as desired.
- If you are finished adding tracks to the program, press the **PROGRAM EDIT** key when the empty program step where it is possible to add a track appears. The unit exits program setting mode.

### NOTE

- The same track can be added to the program multiple times.
- If you press the **STOP** key when the empty program step where it is possible to add a track appears, all steps in the program are cleared.
- If you try to add more than 99 tracks, a "PGM FULL" error message appears. Only 99 tracks can be added.

## Checking the program

You can check the contents of the program.

- Press the **PROGRAM EDIT** key on the remote control to put the unit into program setting mode.

The track number and playback time of the track set as program step 01 is shown on the screen (playback time is not displayed if the loaded disc is a data CD) and **MEMORY** blinks.

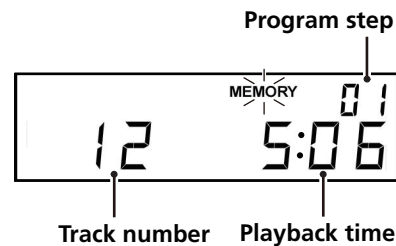

- Press the **PROGRAM EDIT** key to show the track information of the next program step.



- If you press the **PROGRAM EDIT** key when the final program step is shown, it becomes possible to add another program step. (No track number is displayed and the **MEMORY** indicator blinks.)



- Press the **PROGRAM EDIT** key again to exit the program setting mode.

## 4 – Playing back CDs

### Replacing a program track

You can replace a track that has already been added to the program.

- 1 Press the PROGRAM EDIT key on the remote control to put the unit into program mode.
- 2 Follow the steps in “Checking the program” above and press the PROGRAM EDIT key to show the program step with the track that you want to replace.
- 3 Use the numeric keys or skip (◀◀/|◀◀, ▶▶/|▶▶) keys to select the desired track and press the PROGRAM EDIT key.

After replacing a track, the display shows the empty step at the end of the program and you can add another track to the end of the program if desired.

- 4 Press the PROGRAM EDIT key again to exit program setting mode.

### Adding more program tracks

You can add tracks to the end of an already set program.

- 1 Press the PROGRAM EDIT key on the remote control to put the unit into program setting mode.
- 2 Press the PROGRAM EDIT key until the empty program step where it is possible to add a track appears. (No track number is displayed and the MEMORY indicator blinks.)
- 3 Use the numeric keys or skip (◀◀/|◀◀, ▶▶/|▶▶) keys to select a track and press the PROGRAM EDIT key.
- 4 In this state, you can repeat step 3 to add more tracks, or you can press the PROGRAM EDIT key to exit program setting mode.

### Clearing the program

You can clear the entire program that has been set.

- 1 Press the PROGRAM EDIT key on the remote control to put this unit into program setting mode.
- 2 Press the PROGRAM EDIT key until the empty program step appears. (No track number is displayed and MEMORY blinks.)
- 3 Press the STOP key. “-CLEAR-” appears on the display. After the program is cleared, program setting mode resumes without any tracks added to the program.



-CLEAR-

#### NOTE

In addition to the above procedure, opening the disc tray also clears the program.

### Time and text information display

You can set what type of time and text information is shown on the display.

Press the DISPLAY key on the main unit or the remote control to show for two seconds the type of information (playback time or text information) that is currently set to appear in the main area of the display. Press this key again while this is being shown to change the type of information displayed.

The contents that can be displayed differ depending on the type of disc loaded, its status and the operation state of the unit.

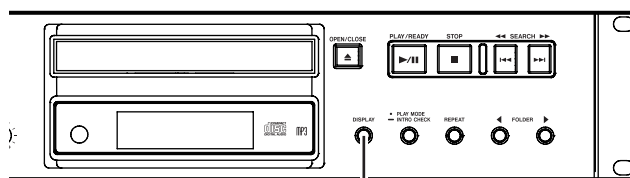

DISPLAY key

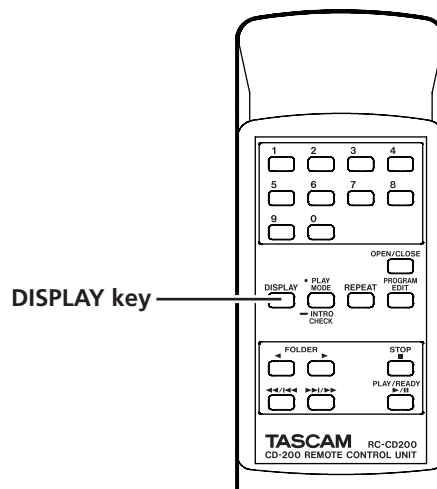

DISPLAY key

#### Audio CDs with CD text

When stopped, the display cycles through total time, album title and album artist. When playing back or paused, the display cycles through track elapsed time, track remaining time, total remaining time, track title and track artist.

#### Audio CDs without CD text

When stopped, playback time is displayed. When playing back or paused, the display cycles through track elapsed time, track remaining time and total remaining time.

#### Data CDs

When stopped, the display switches between total number of tracks and album title (current folder). When playing back or paused, the display cycles through track elapsed time, title, artist and file.



# 4 – Playing back CDs

## NOTE

- After pressing the DISPLAY key, the currently selected type of information to be shown on the main display appears for two seconds as follows.  
Track elapsed time: ELAPSED  
Track remaining time: REMAIN  
Total remaining time: T REMAIN  
Album/track title: TITLE  
Album/track artist: ARTIST  
File name: FILENAME
- The text information that can be shown on the display is ID3 tag information for data CDs and CD text information for audio CDs. When this information is not included for a disc or file or the information contains characters that cannot be displayed, "NO TITLE" (title information) or "NO NAME" (artist information) is shown.
- When an audio CD is in programmed playback mode the elapsed time and remaining time of the entire program is shown.
- The display contents setting is retained even when the power is turned off.

## Repeat playback

You can play a selected track or all tracks repeatedly.

Press the REPEAT key on the main unit or the remote control to select from one of the following repeat modes.

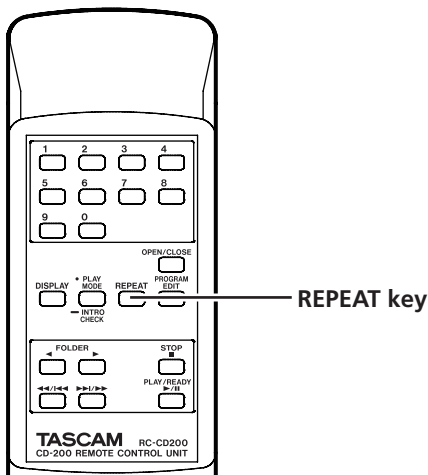
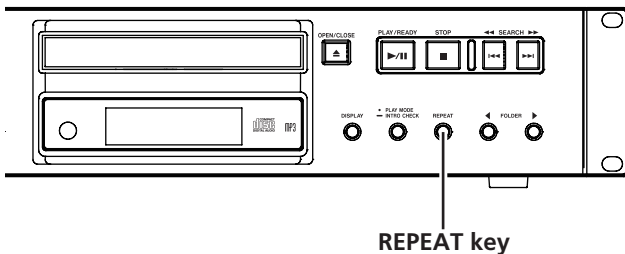

### Single repeat (REPEAT indicator appears):

The selected track is played back repeatedly.

### All repeat (REPEAT and ALL indicators appear):

All tracks\* are played back repeatedly.

- \* When set to folder playback with a data CD, all tracks in the folder are repeated. When using programmed playback, all tracks in the program are repeated.

### Off (no indicator on the display):

Repeat playback is OFF.

### Turning repeat playback OFF:

Press the REPEAT key on the main unit or the remote control until the ALL and REPEAT indicators do not appear.

## NOTE

- If single repeat playback is turned ON during playback, the current track is played back repeatedly. If all repeat playback is turned ON during playback, playback continues as it is until the end of the disc or current folder is reached. Then, playback continues from the beginning of the disc or current folder. If repeat playback is turned ON when stopped, repeat playback begins when the PLAY/READY key is pushed.
- The repeat function's ON/OFF state is retained even when the power is turned OFF.

## Pitch control

Using pitch control playback, CDs can be played back at a different pitch (sound frequency and playback speed).

Follow the procedures below to use pitch control playback.

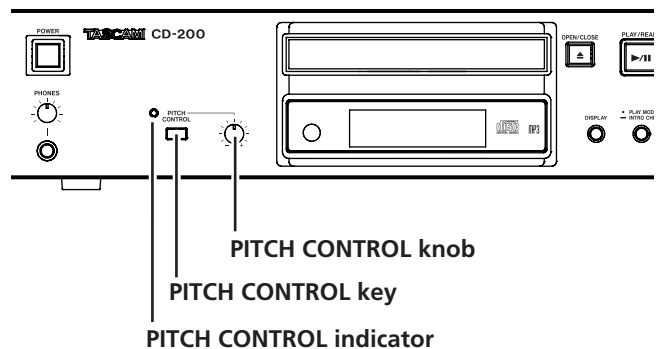

- 1 Press the PITCH CONTROL key on the main unit to turn pitch control playback ON.

The indicator above and to the left of the PITCH CONTROL key lights.

- 2 Use the PITCH CONTROL knob to set the pitch.

Pitch can be adjusted by  $\pm 12.5\%$ .

To turn pitch control playback OFF, press the PITCH CONTROL key on the main unit again.

The PITCH CONTROL indicator goes off and pitch control playback turns OFF.

# 4 – Playing back CDs

## CAUTION

- During playback, turning pitch control playback ON or OFF might cause the playback sound to skip momentarily.
- Using pitch control playback with a data CD (MP3, WAV) sometimes causes the playback sound to skip.

## Intro Check

During playback or when stopped, press and hold the PLAY MODE/INTRO CHECK key on the main unit or the remote control to playback only the first 10 seconds of each track.

The **INTRO** indicator lights when this function is ON.

When Intro Check is ON, press and hold the PLAY MODE/INTRO CHECK key on the main unit or the remote control again to return to the ordinary playback mode and turn the **INTRO** indicator OFF.

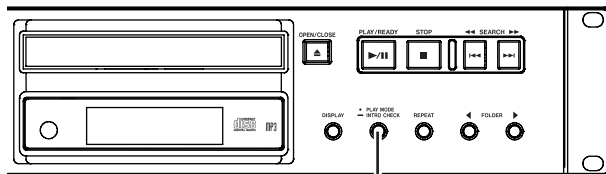

PLAY MODE  
INTRO CHECK key

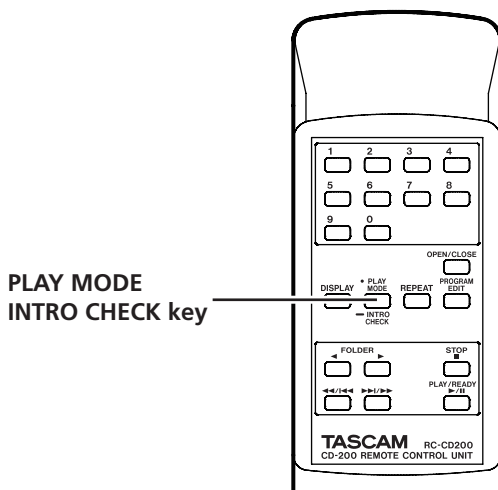

PLAY MODE  
INTRO CHECK key

- When using Intro Check, press the SEARCH  $\lll/\ggg$  ( $\lll/\ggg$ ) keys on the main unit or the search ( $\lll/\lll$ ,  $\ggg/\ggg$ ) keys on the remote control to skip to the preceding or next track.
- Press the STOP key to stop Intro Check.

# 5 – Message Lists

## Operation messages

The following messages are shown on the main display according to the operation of the CD player.

Message	Message lit or blinking	Meaning	Response
-CLEAR-	Lit	All programs have been cleared.	
CLOSE	Lit	The disc tray is closing.	
NO DISC	Lit	There is no disc or the disc cannot be verified.	
NO FILES	Lit	The disc has no files that can be played back.	Load a disc that has MP3 or WAV files.
NO NAME	Lit	There is no artist data or no file data that can be displayed	Text information must be 7-bit ASCII compatible text to be displayed.
NO TITLE	Lit	There is no title data that can be displayed.	Text information must be 7-bit ASCII compatible text to be displayed.
OPEN	Lit	The disc tray is open.	
TOC READ	Lit	TOC information is being read.	

## Warning messages

If an operation cannot be completed, one of the following messages is shown. It will appear for about two seconds before disappearing automatically.

Message	Message lit or blinking	Meaning	Response
NO PGM	Lit	No program has been created.	Add tracks to the program.
PGM FULL	Lit	You cannot add more than 99 tracks to the program.	Either stop trying to add to the program, clear the program, or replace one of the tracks in the program.

## Error messages

If one of the following error messages is shown, please refer to the Response column and try to resolve it. If this does not correct the problem, please contact a TEAC repair center.

Message	Message lit or blinking	Meaning	Response
COMM ERR	Blinking	Cannot communicate with the CD drive.	Contact a TEAC repair center.
COMM ERR	Lit	An error occurred during communication with the CD drive.	Contact a TEAC repair center.
DEC ERR	Lit	The file type is not supported or otherwise could not be played	Change the disc
DISC ERR	Lit	The TOC or file system could not be read, or focus adjustment was not possible.	Clean or change the disc.
DRV ERR	Lit	The CD drive hardware is broken.	Contact a TEAC repair center.
READ ERR	Lit	The track cannot be accessed.	Clean or change the disc.

## 6 – Troubleshooting

If you have problems with your system, look through this chart and see if you can solve the problem yourself before calling your dealer or TEAC service center.

### ■ **No power**

➔ Check the connection to the AC power supply.

### ■ **Remote control doesn't work.**

➔ Check to see if the batteries are properly installed in the remote control.

➔ If the batteries are dead, change the batteries.

### ■ **No sound**

➔ Check the connection to the monitor system again.

➔ Check the volume and settings of the amplifier.

### ■ **There is unwanted noise.**

➔ Are the connecting cables all properly connected and functioning?

### ■ **A CD cannot be played back.**

➔ If you are using a data CD with MP3 files, confirm that the file bit-rates are compatible with this unit.

➔ Is the disc scratched or dirty?

### ■ **The files on a data CD cannot all be played back.**

➔ Is the unit in folder playback mode?

# 7 – Specifications

---

## Ratings

---

### ■ Compatible disc formats

CD-DA (12-cm/8-cm), CD-ROM (12-cm/8-cm) ISO 9660  
LEVEL 1/2/ROMEO/JOLIET format (CD-R/CD-RW  
DISC compatible)

### ■ MP3 playback specifications

Audio Mode: STEREO/JOINT STEREO/DUAL  
CHANNEL/MONO/VBR

- MPEG 1 Audio Layer III (MP3)
- Sampling Frequency: 32 kHz/44.1 kHz/48 kHz
- Bit Rate: 32 kbps - 320 kbps

### ■ WAV playback specifications

Sampling Frequency: 8 kHz/11.025 kHz/12 kHz/16  
kHz/22.05 kHz/24 kHz/32 kHz/44.1 kHz/48 kHz

Sampling Bit Rate: 8 bit/16 bit

### ■ Audio CD Playback Specifications

Sampling Frequency: 44.1 kHz

Sampling Bit Rate: 16 bit

Number of Channels: 2

### ■ Audio Performance

Frequency Response: 20 Hz - 20 kHz  $\pm 1.5$  dB

Signal-to-Noise Ratio (S/N): More than 90 dB (20 kHz  
LPF + A-weighted)

Distortion (THD + N): Less than 0.01% (1 kHz: 20 kHz  
LPF)

Dynamic Range: 90 dB min.

Channel Separation: 90 dB min. (1 kHz: 1 kHz BPF)

### ■ ANALOG OUTPUT [UNBALANCED] Terminal

Connector: RCA pin jack

Reference Output Level: -10 dBV

Maximum Output Level: +6 dBV

Output Impedance: 200 $\Omega$

### ■ PHONES Jack

Headphone Output

Connector: Standard Stereo Jack

Rated Output: 20 mW + 20 mW min.

(When monitoring CD, THD + N 0.1% max., 32 $\Omega$   
load)

### ■ DIGITAL OUTPUT [COAXIAL] Terminal

Connector: RCA Pin Jack

Compatible Signal Format: IEC-60958-3 (S/PDIF)

Output Impedance: 75 $\Omega$

### ■ DIGITAL OUTPUT [OPTICAL] Terminal

Connector: Optical Jack

Compatible Signal Format: IEC-60958-3 (S/PDIF)

---

## General

---

### ■ Power Requirement

AC 120 V, 60 Hz (U.S.A./Canada)

AC 230 V, 50 Hz (U.K./Europe)

AC 240 V, 50 Hz (Australia)

### ■ Power Consumption

11 W

### ■ Dimensions (W x H x D)

481 x 94.5 x 298 (mm) / 18.94 x 3.72 x 11.73 (in)

### ■ Weight

4.2 kg (9.259 lb)

### ■ Operating Temperature

5 to 35°C

### ■ Inclination of installation

5° or less

- Illustrations and other depictions may differ in part from the actual product.
- Specifications and external appearance may be changed without notification to improve the product.

# 7 – Specifications

## Dimensions

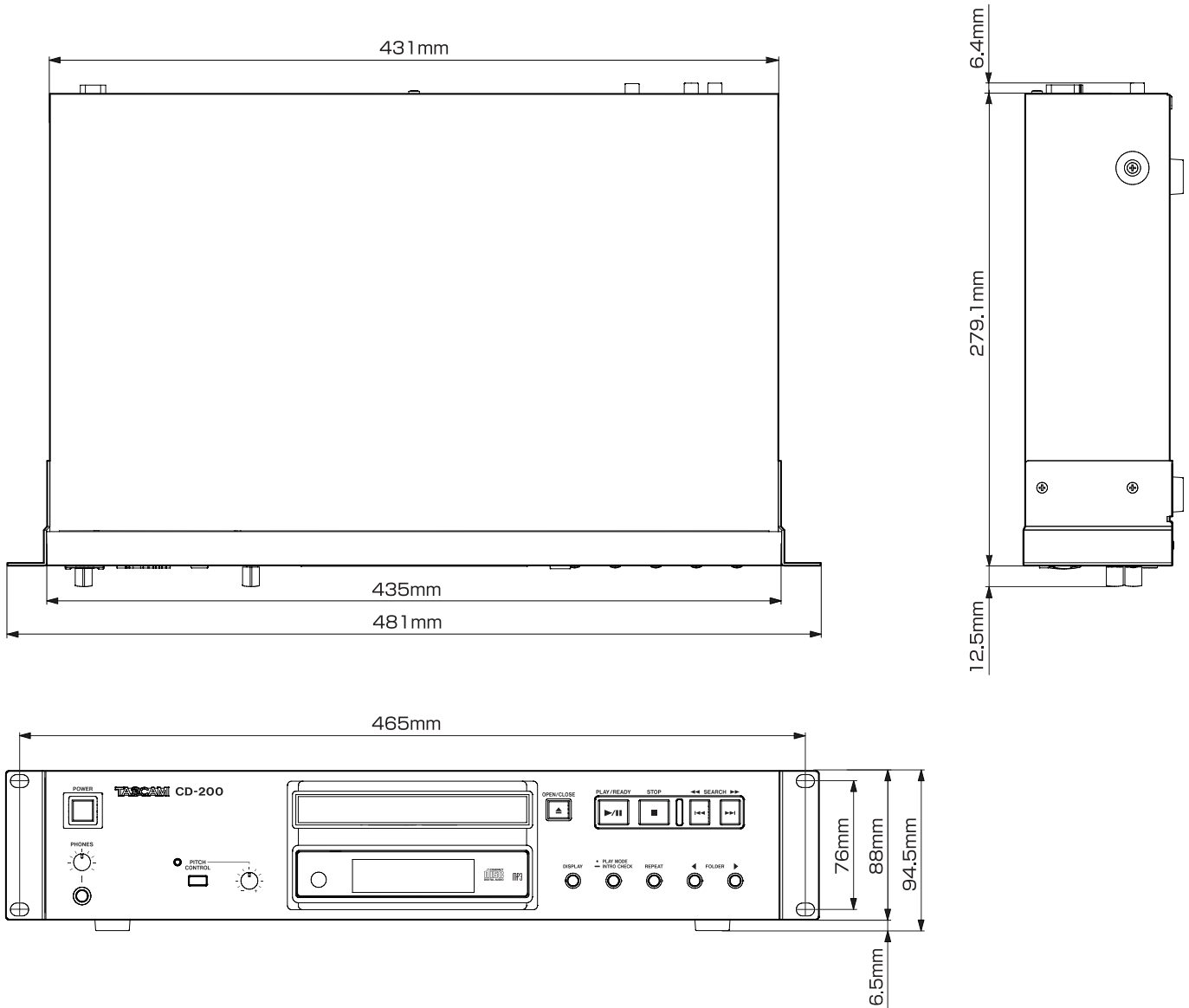





**TASCAM**<sup>®</sup>  
TEAC PROFESSIONAL

# CD-200

**TEAC CORPORATION**

Phone: +81-42-356-9143  
1-47 Ochiai, Tama-shi, Tokyo 206-8530, Japan

[www.tascam.jp](http://www.tascam.jp)

**TEAC AMERICA, INC.**

Phone: +1-323-726-0303  
7733 Telegraph Road, Montebello, California 90640 USA

[www.tascam.com](http://www.tascam.com)

**TEAC CANADA LTD.**

Phone: +1905-890-8008 Facsimile: +1905-890-9888  
5939 Wallace Street, Mississauga, Ontario L4Z 1Z8, Canada

[www.tascam.com](http://www.tascam.com)

**TEAC MEXICO, S.A. de C.V.**

Phone: +52-55-5010-6000  
Río Churubusco 364, Colonia Del Carmen, Delegación Coyoacán, CP 04100, México DF, México

[www.teacmexico.net](http://www.teacmexico.net)

**TEAC UK LIMITED**

Phone: +44-8451-302511  
Suites 19 & 20, Building 6, Croxley Green Business Park, Hatters Lane, Watford, Hertfordshire, WD18 8TE, UK

[www.tascam.co.uk](http://www.tascam.co.uk)

**TEAC EUROPE GmbH**

Phone: +49-611-71580  
Bahnstrasse 12, 65205 Wiesbaden-Erbenheim, Germany

[www.tascam.de](http://www.tascam.de)